

PLAN VIEW

BIKE PROOF, HEAVY
DUTY TRAFFIC GRATE
SUPPORTS AASHTO
H2O LOADS

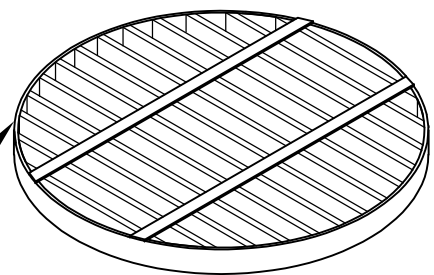

GRATING

NOTES:

BOX FABRICATED FROM
10 GA. MILD STEEL

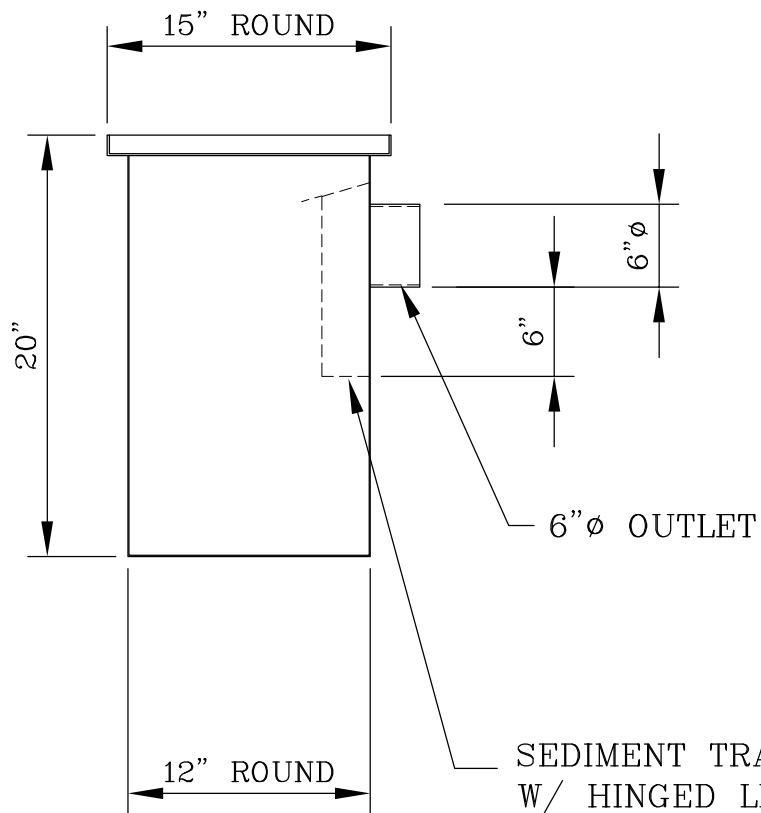

SIDE VIEW

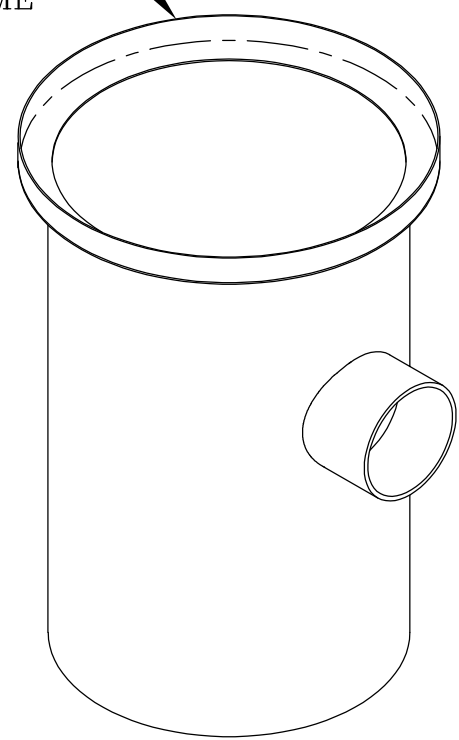

ISOMETRIC

STATE APPROVED — ASPHALT DIPPED

12" ROUND — 6" ϕ OUTLET

ROUND STORM WATER CATCH BASIN

MODEL: RCB12-20HB-6

DATE: 11/19/2020

SCALE: NONE

DWG #
R1

Gibson Steel Basins, Inc.

1040 Arrowsmith St. Eugene Or. 97402
(541) 484-7200 or (800) 574-8096

Visit us at: www.gibsonsteelbasins.com
Email us at: sales@gibsonsteelbasins.com

EST. 1996

CCB 150089