

PLAN VIEW

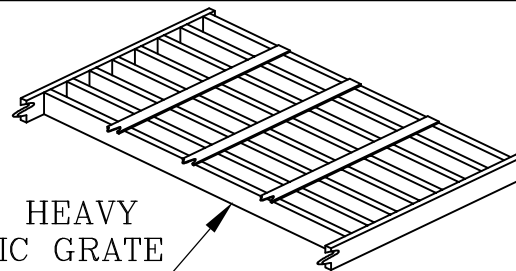

BIKE PROOF, HEAVY
DUTY TRAFFIC GRATE
SUPPORTS AASHTO
H20 LOADS

GRATING

NOTES:

BOX FABRICATED FROM
10 GA. MATERIAL

4" ϕ OR 6" ϕ
OUTLET

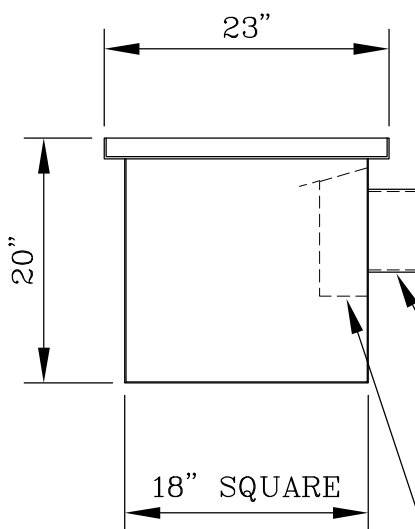

SIDE VIEW

L2 $\frac{1}{2}$ x2 $\frac{1}{2}$ x $\frac{3}{16}$
FRAME

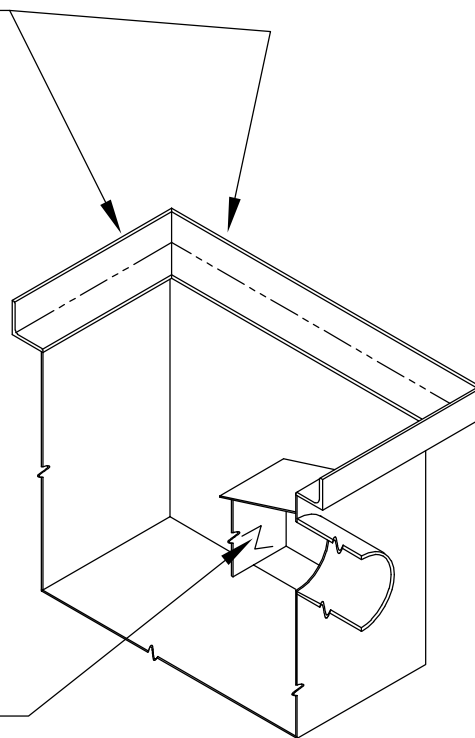

ISOMETRIC SECTION

4" ϕ OR 6" ϕ
OUTLET

SEDIMENT TRAP
W/ HINGED LID

STATE APPROVED — ASPHALT DIPPED

18" SQUARE — 4" ϕ OR 6" ϕ OUTLET

COMPACT BASIN

MODEL: GCB10-1820HB-4&6

DATE: 11/19/2020

SCALE: NONE

DWG #

C1

Gibson Steel Basins, Inc.

1040 Arrowsmith St. Eugene Or. 97402
(541) 484-7200 or (800) 574-8096

Visit us at: www.gibsonsteelbasins.com
Email us at: sales@gibsonsteelbasins.com

EST. 1996

CCB 150089