

PLAN VIEW

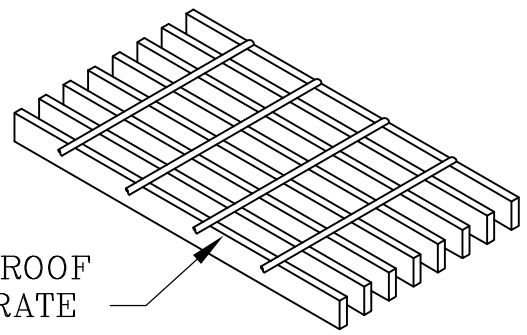

GRATING

NOTES:

BOX FABRICATED FROM
10 GA. MATERIAL

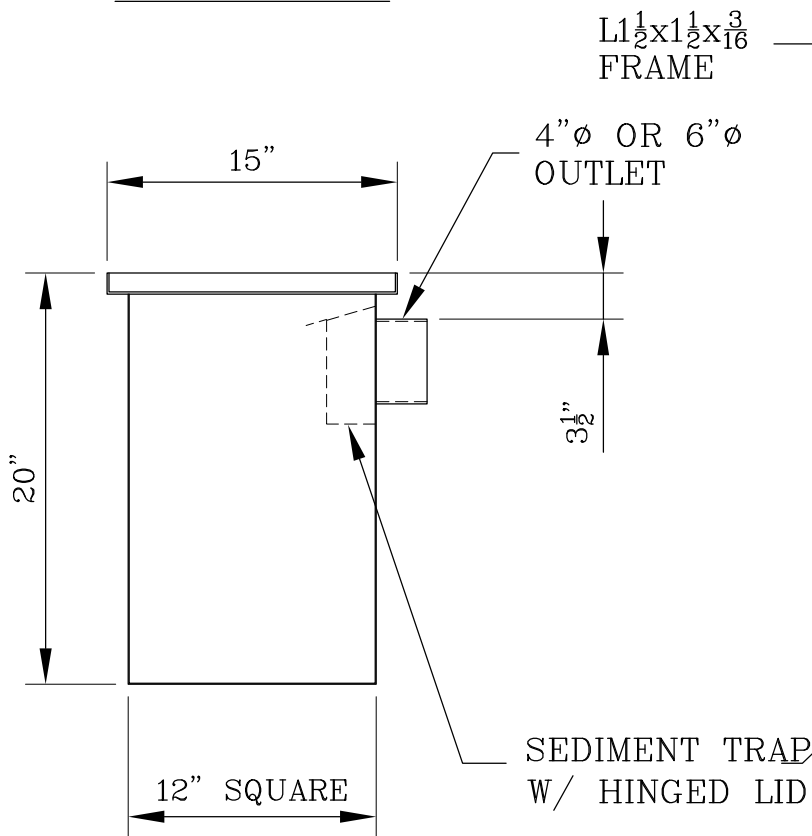

SIDE VIEW

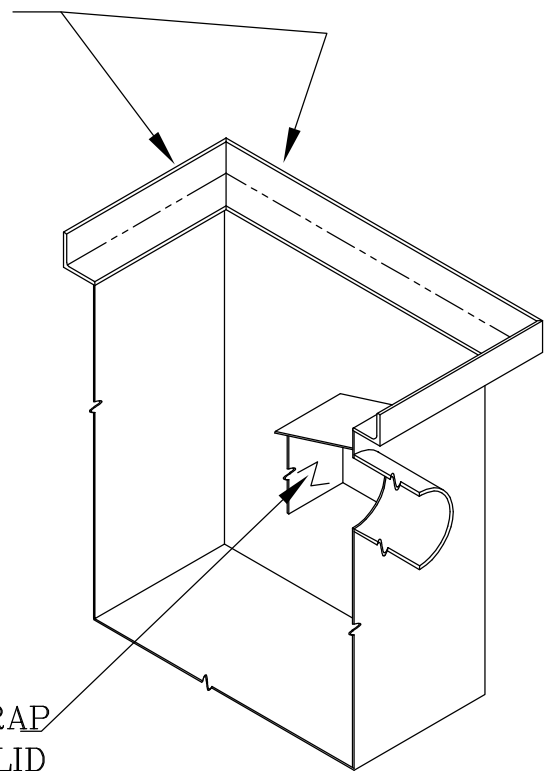

ISOMETRIC SECTION

STATE APPROVED — ASPHALT DIPPED



Gibson Steel Basins
SINCE 1972

12" SQUARE — 4" ϕ OR 6" ϕ OUTLET

LANDSCAPING MINI-BASIN

PROJ. MAN. DOUG P.

DWN. PAUL G.

SCALE NONE

DATE: JAN. 23, 06

MODEL: GMCB10-1220HB-4&6

DWG #

L4